



DATASHEET

AVEVA™ Process Simulation

formerly SimCentral

Design sustainable processes at the speed of the market

AVEVA Process Simulation is an innovative, integrated platform that helps you develop the process side of your digital twin so your teams work smarter while designing a sustainable world. AVEVA Process Simulation helps engineers create value in every phase of the plant lifecycle, from concept to ongoing operations.

Overview

In chemical and energy organizations, public commitments to net zero emissions and circular economy goals are creating unprecedented demands for sustainable products, processes, and plants. Engineering departments span the globe and respond to changing conditions in markets and regulatory agencies. A new generation of engineers is entering the workforce. Plants are more complex and more tightly integrated. Legacy process simulators are ill-suited to these challenges.

AVEVA Process Simulation is designed to equip the next generation of engineers to create the process portion of the digital twin. Engineers collaborate across disciplines to explore all dimensions of a potential design and quantify the impact on sustainability, feasibility, and profitability. AVEVA Process Simulation is the first simulation platform to move beyond linear, wasteful workflows to enable a circular and sustainable world.

Business value

- **Digital transformation:** Integrate process engineering with the digital twin
- **Lifecycle simulation:** Reuse one simulation across all engineering phases
- **Faster adoption:** Replace dozens of point solutions with a single, easy-to-use interface
- **Multi-discipline collaboration:** Change the engineering workflow with concurrent use by process, utility, control, and mechanical engineers
- **Attract and retain talent:** Make engineering less about button pressing and more about creative problem solving

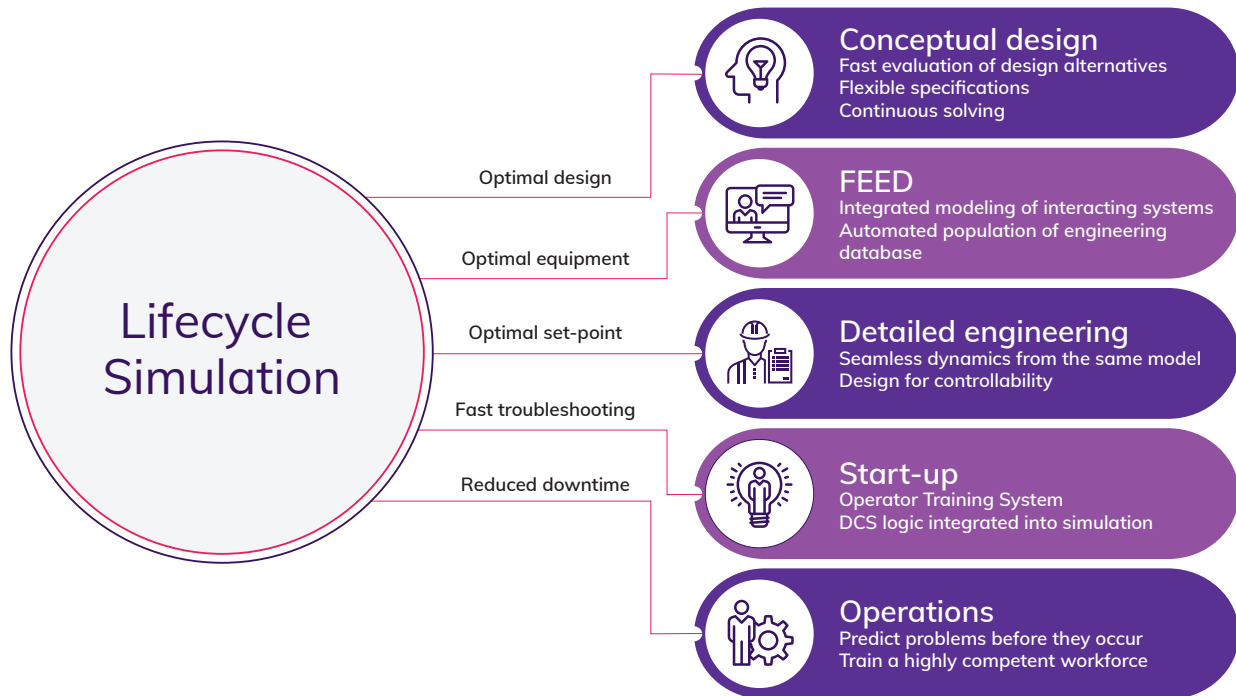

AVEVA Process Simulation features

With legacy tools, even small projects require multiple, specialized simulators. Engineers waste time learning interfaces and transferring data, introducing errors along the way.

A unified modeling environment improves user experience, IT accessibility, cross-tool integration, and time to proficiency, combined with a lower cost of ownership. Like a smartphone for process engineers, AVEVA Process Simulation unifies many uses into a single, integrated platform to design and optimize a process plant.

AVEVA Process Simulation impacts the daily work of your entire team with a transformational approach to process simulation. AVEVA Process Simulation meets the needs of new engineers, process experts, and their managers with features and workflows built for three key qualities: ease of use, solution power, and adaptability.

- Steady state and dynamics
 - Change modes any time and in any direction between flow-driven steady state, pressure-driven rating, and dynamics
- Sustainability is built-in
 - Greenhouse gas calculations are available in the economics library. Solar, wind, and hydrogen models are also available in the renewables library
- Open modeling
 - See, understand, and customize model equations. Write new models with no programming
- Enhanced equation-oriented
 - State-of-the-art numerics allow efficient calculation, especially when there are many recycles and design optimization
- Open platform
 - Expand into new areas of simulation and integrate with new technologies with built-in Python scripting
- Real-time data
 - Automatically input real-time data from operations through the native connection with the PI System

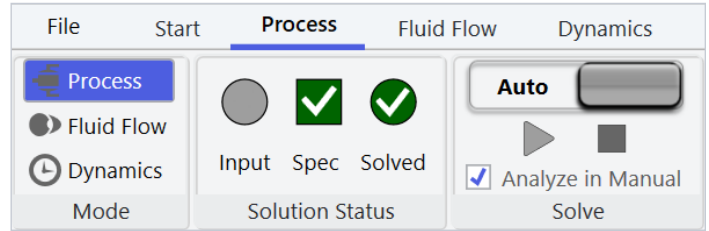

Switch modes at any time in any direction

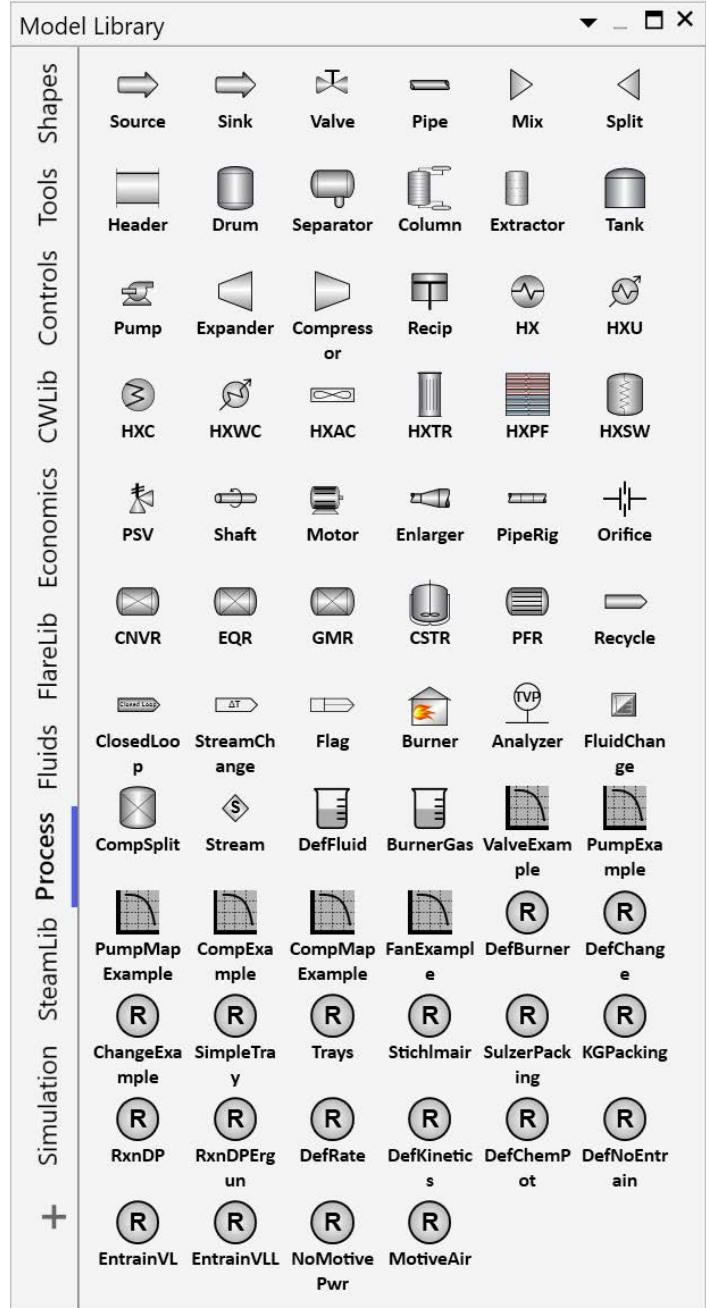

AVEVA Process Simulation has extensive standard model libraries

Application areas

Chemical processes

AVEVA Process Simulation is ideal for chemical process simulation, especially complex systems with many recycles, where conventional simulators perform poorly. Some of the features for chemical processes include:

- A process library with distillation columns, reactors, heat exchangers, compressors, and other common unit operations
- Fluid thermodynamics methods, including SRK, SRKM, Predictive SRK, PR, PRM, NRTL, electrolyte NRTL, UNIQUAC, UNIFAC, Wilson, Hayden O'Connell, IF97, and more added each release
- Interface with the thermodynamics data manager to define custom components
- Use simulation-independent fluid objects, which can be defined with custom components and reused throughout your organization
- Easy-to-use optimization tools improve process design and offer opportunities for sustainability enhancements, such as better cooling and heating systems to minimize greenhouse gas emissions
- Integrated dynamic simulations offer better distillation column relief load calculations

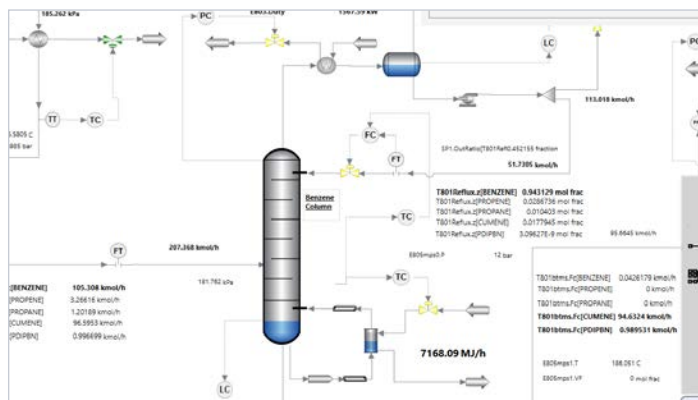

Optimize chemical processes for sustainability and performance

Renewables and sustainability

Design renewable power generation networks for wind turbines, solar panels, electrical distribution, and hydrogen electrolysis. AVEVA Process Simulation easily handles the dynamic nature of renewables.

- Track greenhouse gas emissions from the earliest design concept using the same workflows you use to analyze and optimize profitability and efficiency
- Evaluate the effect of green hydrogen processes on the heat and material balance of an existing facility
- Explore design alternatives for electricity and hydrogen storage to enable better decision making in conceptual design

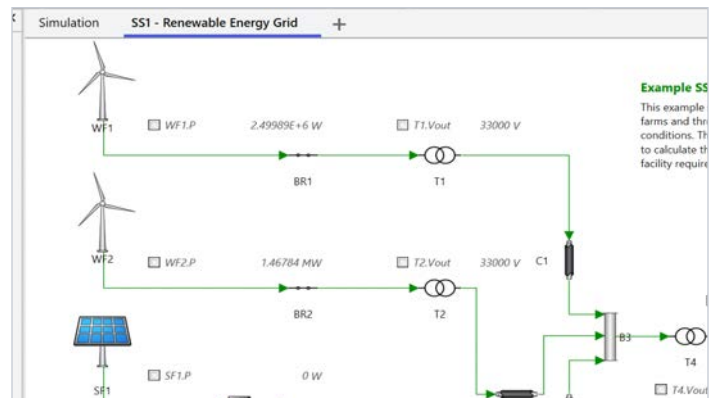

Evaluate design options for renewable power generation networks

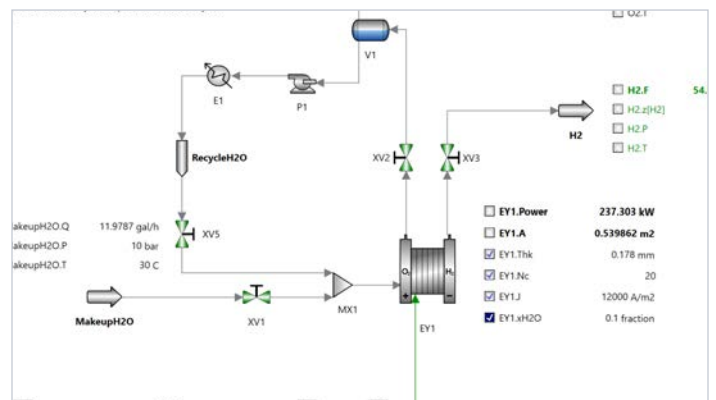

Explore green hydrogen processes within a larger facility



Process utilities

Process utility engineers can use a single simulation for cooling water or steam balances, then change mode to perform a piping flow network analysis and dynamic simulation. The capabilities include:

- A steam library with boilers, steam turbines, extraction turbines, desuperheaters, and condensers
- A cooling water library with supply, return, pipes, pumps, and exchangers
- A transient Flow library for water hammer and pressure surge analysis
- Fluid thermodynamics methods such as steam (IF97), cooling water, other heat transfer mediums

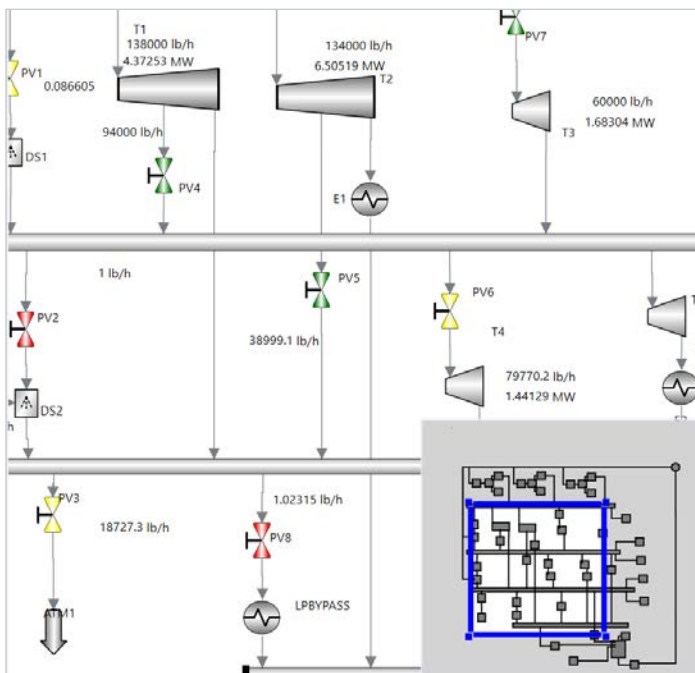

Integrate utilities analysis in a single simulation

Flare networks

AVEVA Process Simulation's flare library provides an easy way to evaluate multiple relief scenarios and immediately see back pressure predictions. Flare networks are evaluated in the same software environment as chemical processes and process utilities for easy coordination of engineering changes. The flare library includes:

- Relief valves, tail pipes, and flare stacks.
- Robust flare network solutions, especially with multiple stacks and crossovers.

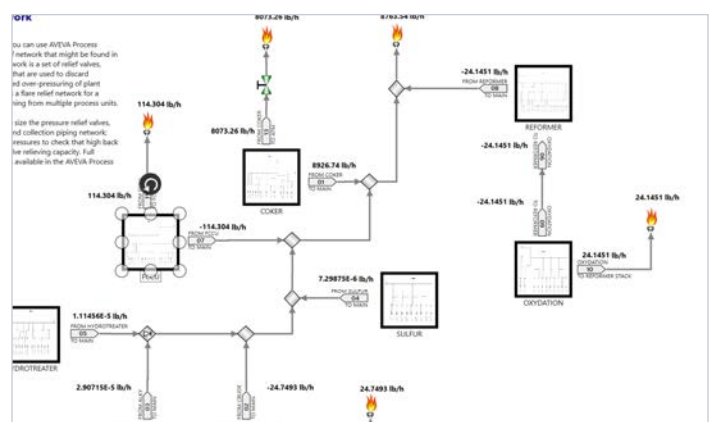

Dynamic simulation of complex flare networks

The AVEVA advantage

AVEVA powers digital transformation for industrial organizations. AVEVA Process Simulation is a key part of the AVEVA industrial software ecosystem and benefits from a deep portfolio of infrastructure platforms and process solutions.

AVEVA™ Connect

AVEVA Connect is our common cloud platform, providing a central location to securely access the broadest and deepest industrial software-as-a-service (SaaS) portfolio on the market. AVEVA software in the cloud powers sustainable growth, enabling you to transform faster, reduce costs, and easily scale.

Learn more: aveva.com/en/solutions/aveva-connect

AVEVA™ Flex

Achieve faster return-on-investment and remove traditional barriers to software adoption with a flexible subscription program. The AVEVA Flex subscription program spans any mix of cloud, hybrid, and on-premises solutions with simplicity in the license purchase, usage, and management.

Learn more: aveva.com/en/solutions/flex-subscription

AVEVA™ Unified Engineering

AVEVA Unified Engineering is the new standard for capital project engineering and design collaboration. It integrates all process simulation and engineering (1D, 2D, 3D) data in one single data-centric hub on AVEVA's secure cloud environment. Bi-directional information flow allows you to execute concurrent, multi-discipline engineering for greater control over change across the entire project.

Learn more: aveva.com/en/products/unified-engineering

AVEVA™ Unified Learning

AVEVA Unified Learning delivers engaging training programs for competency-based experiential learning, so your operators perform better in less time. It provides cloud access to our vast portfolio of training and simulation applications including Operator Training Simulators (OTS) and virtual reality. Leverage your investment in process simulation to quickly build a high fidelity OTS.

Learn more: aveva.com/en/products/unified-learning

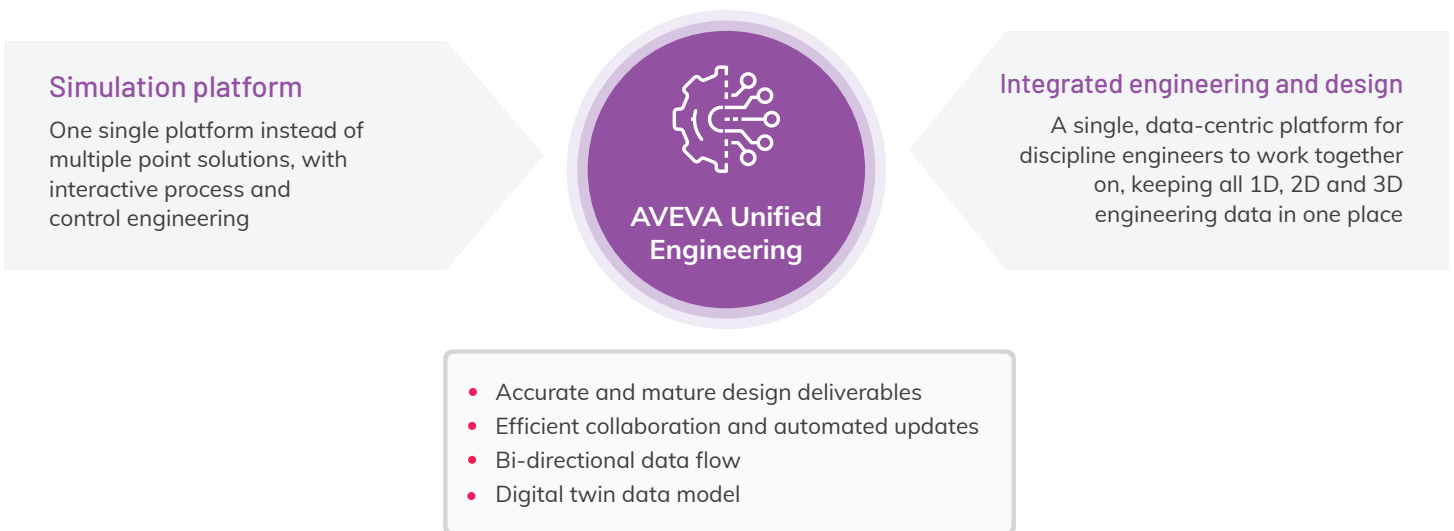

AVEVA Process Simulation is a key element of Unified Engineering

Success stories

Covestro

Owner Operator / Chemicals

Pushing boundaries is a key theme at Covestro, one of the world's largest polymer companies. By standardizing one process design, engineering, and simulation tool, Covestro cuts cost and inefficiencies across its process lifecycle.

Learn more:

aveva.com/perspectives/success-stories/covestro

Promon Engenharia

EPC / Oil & Gas, Power

Promon, an energy plant solutions provider in Brazil, needed flexible, scalable engineering and simulation tools to reduce time spent on engineering and installation. By implementing digital twins based on AVEVA Unified Engineering and AVEVA Process Simulation, it reduced engineering hours by 15% and implemented projects 60% faster.

Learn more:

aveva.com/perspectives/success-stories/promon-engenharia

Federal University of Campina Grande

Academic

The Federal University of Campina Grande attracts thousands of students from throughout Brazil and the world seeking education in modern technology. Understanding the steps of process modeling, from the mathematical equations to the simulation application, is fundamental for a comprehensive education.

Learn more:

aveva.com/perspectives/success-stories/ufcg

Watch the Demo

aveva.com/campaigns/aveva-process-simulation-demo-video

For more information on AVEVA Process Simulation, please visit: aveva.com/en/products/process-simulation